



MULTIUSO SPARTA
Código 7479

Benetil
Móveis

Av. Jesus Candian, 395 - B. Mangueira Rural
Telefax (32) 3539-5350
CEP 36500-000 - Ubá - Minas Gerais
www.benetil.com.br

RELAÇÃO DE FERRAGENS EM TAMANHO REAL (MEDIDA EM MILÍMETRO).

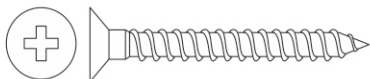

A - PARAF. 4,5x40



B - PARAF. 4,0x25



C - PARAF. 3,5x14



D - PREGO 8x8



F - CAVILHA MADEIRA



G - PUXADOR

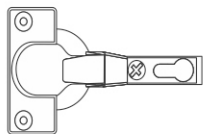

H - DOBRADIÇA | CALÇO

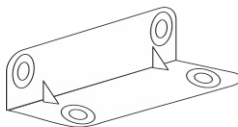
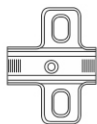

I - CANTONEIRA 4 FUROS

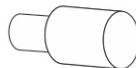

J - PINO PRATELEIRA

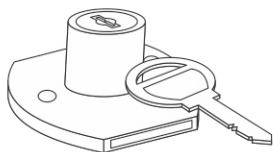

L - FECHADURA COM CHAVE



M - TAMPA ADESIVA



N - CALÇO FECHADURA

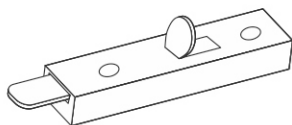

O - TRINCO

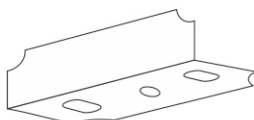

P - LINGUETA TRINCO



FAVOR IDENTIFICAR AS PEÇAS E COLOCAR SEUS RESPECTIVOS ACESSÓRIOS

ATENÇÃO: MONTAR COM O MÓVEL DEITADO.

Sequência de Montagem

- 01 - Comece a montagem pela peça 1;
02 - Encaixar e Parafusar as peças 2 na Lateral 1;

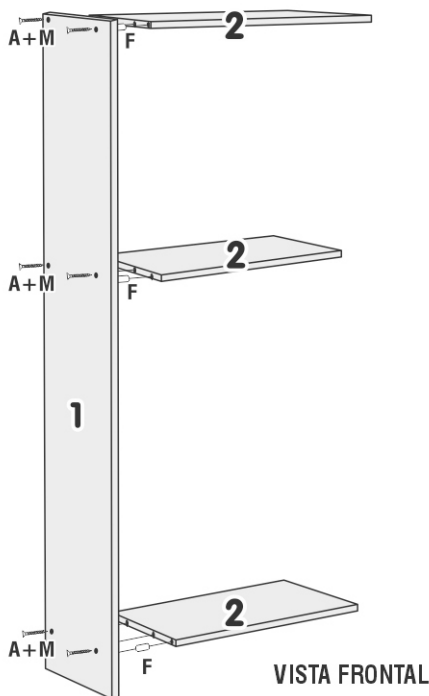
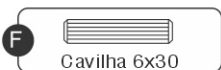
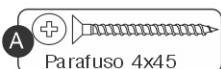

ATENÇÃO: MONTAR COM O MÓVEL DEITADO.

Sequência de Montagem

- 03 - Encaixar e parafusar a Lateral Direita 5 nas peças 2 conforme desenho ao lado;

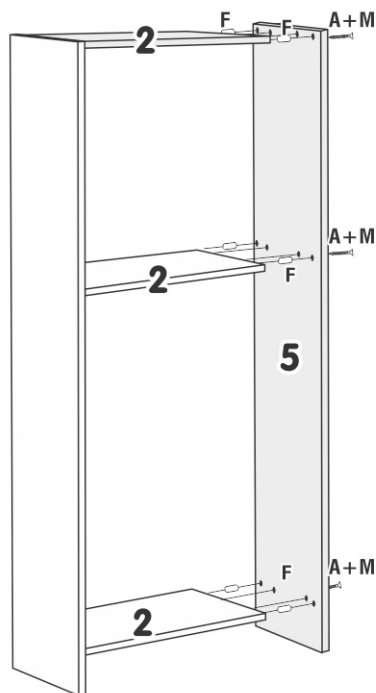
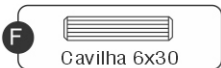
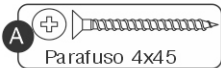

**ATENÇÃO: MONTAR COM
O MÓVEL DEITADO.**

Sequência de Montagem

04 - Encaixar e Parafusar as
peças 3 nas peças 1, 2
e 5;

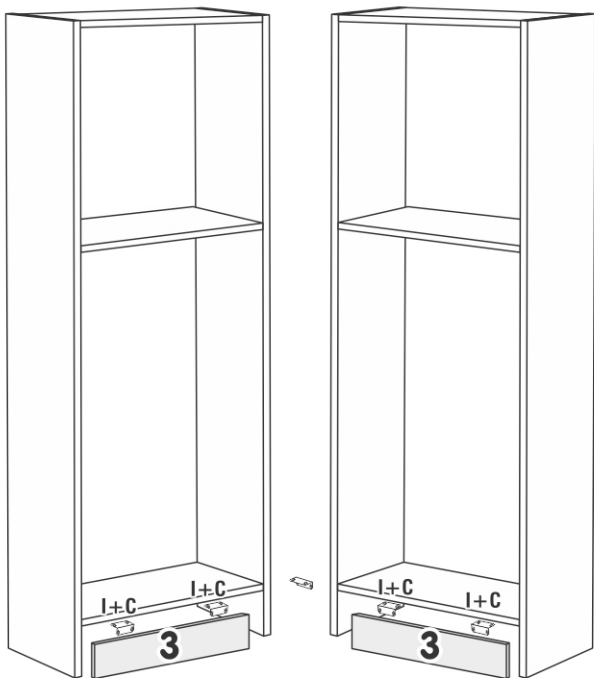

VISTA FRONTAL

VISTA TRASEIRA

Sequência de Montagem

05 - Unir as costas 8 com Perfil H 9 e pregar as
mesmas conforme o desenho ao lado.

06 - Parafusar os Pés 10.

**OBS.: Acertar as costas para melhor
esquadrejamento do móvel, na prateleira 02 é
necessário pregar os pregos a cada 5cm
para reforçar o produto.**

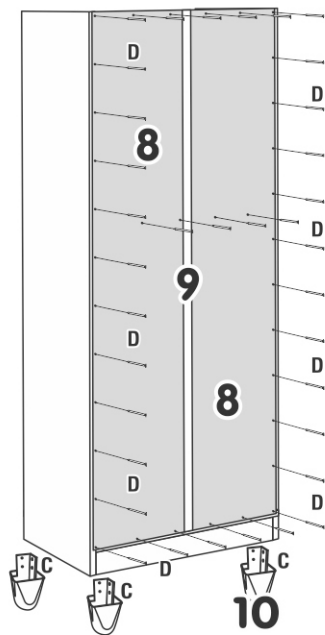
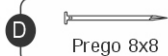

5

Sequência de Montagem

07 - Colocar as Prateleiras Opcionais 4.

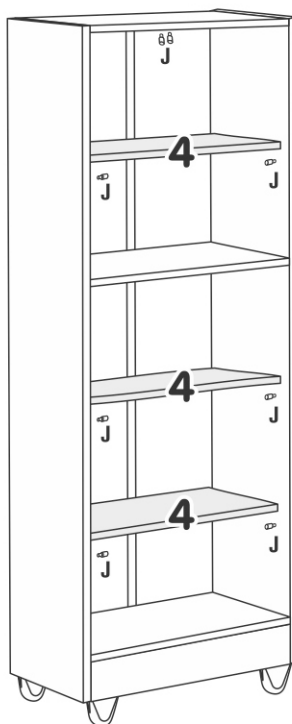

Sequência de Montagem

08 - Montar as portas conforme desenho ao lado;

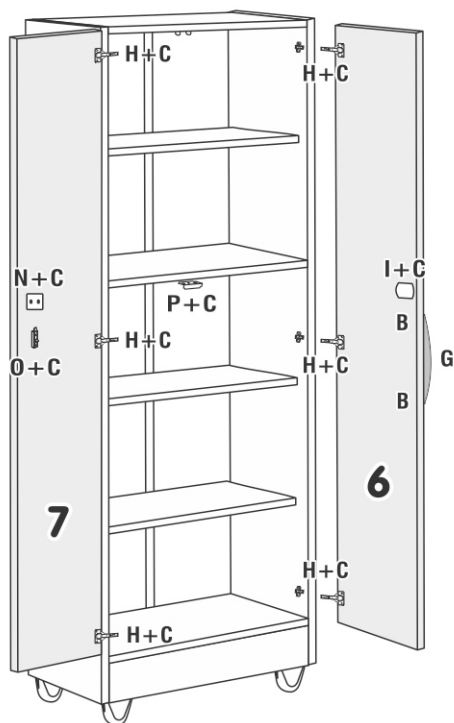
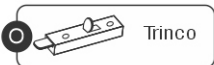
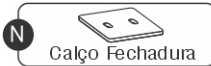
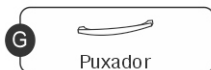
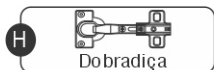
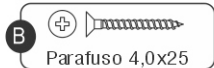

6