



JCM
movelaria

Home Fortuna

Fortuna Entertainment Center

Centro de Entretenimiento Fortuna



Indicamos que a montagem dos produtos seja realizada por um montador profissional e, em caso de dúvidas durante a montagem, ligue para o Departamento de Pesquisa e Desenvolvimento, 55 032 3539-4100.
We recommend that the product assembly be performed by a professional furniture assembler. In case of doubt during the assembly, call our Research and Development Department at 55 032 3539-4100.
Se recomienda que un montador de muebles profesional realice el montaje de los productos. En caso de dudas durante el montaje, llame al Departamento de Investigación y Desarrollo al 55 032 3539-4100.

AVISO: A JCM Movelaria não se compromete pelo mal-uso, montagem e fixação do produto à parede. Portanto, não somos responsáveis por danos e quedas do produto, eletrônicos e pertences neles contidos. É importante o uso de brocas e ferramentas compatíveis na montagem.
ATTENTION: JCM Movelaria is not responsible for misuse, assembly and wall fixation. Therefore, we are not responsible for damages and falls caused to the product, electronics and belongings therein. It is important to use suitable drills and tools for the assembly.
ATENCIÓN: JCM Movelaria no se responsabiliza del mal uso, montaje y fijación del producto a la pared. Por lo tanto, no somos responsables de daños y caídas del producto, electrónicos y objetos que contiene. Es importante el uso de taladros y herramientas compatibles con el montaje.

Dica: Para evitar possíveis avarias, use a embalagem do produto como apoio durante a montagem.















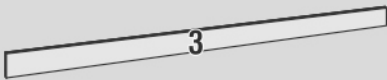









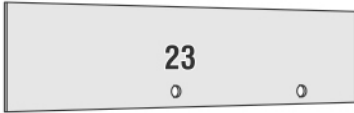

Tip: To avoid damages, use the product packaging as base during the assembly.

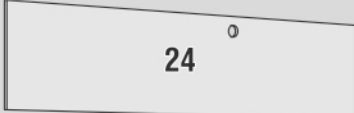
Pista: Para evitar daños, use el envase del producto como apoyo durante el montaje.

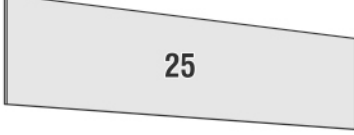
RELAÇÃO DE FERRAGENS | HARDWARE LIST | LISTADO DE HERRAJES

CALÇO DOBRADIÇA	(A)	HINGE MOUNTING PLATE	(A)	BASE DE BISAGRA	(A)		08
CANTONEIRA 4 FUROS	(B)	4-HOLE ANGLE BRACKET	(B)	REFUERZO DE ÁNGULO 4 AGUJEROS	(B)		37
CAVILHA 6x30	(C)	6x30 DOWEL	(C)	CLAVIJA 6x30	(C)		14
CAVILHA 8x30	(D)	8x30 DOWEL	(D)	CLAVIJA 8x30	(D)		02
CHAPA UNIAO 4 FUROS	(E)	4-HOLE CONNECTION PLATE	(E)	PLACA DE UNIÓN 4 AGUJEROS	(E)		04
DOBRADIÇA ALTA 26mm	(F)	26mm HALF OVERLAY HINGE	(F)	BISAGRA ACODADA 26mm	(F)		08
FIXADOR METÁLICO	(G)	METAL FIXING PLATE	(G)	GRAPA TRASERA	(G)		02
PARAFUSO 3,5x12	(H)	3.5x12 SCREW	(H)	TORNILLO 3,5x12	(H)		108
PARAFUSO 3,5x14	(I)	3.5x14 SCREW	(I)	TORNILLO 3,5x14	(I)		100
PARAFUSO 3,5x25	(J)	3.5x25 SCREW	(J)	TORNILLO 3,5x25	(J)		24
PARAFUSO 5x40 FLANGEADO	(K)	5x40 FLANGE SCREW	(K)	TORNILLO FLANGE 5x40	(K)		04
PARAFUSO 5x40	(L)	5x40 SCREW	(L)	TORNILLO 5x40	(L)		30
PARAFUSO 5x50	(M)	5x50 SCREW	(M)	TORNILLO 5x50	(M)		04
PARAFUSO MINIFIX	(N)	MINIFIX BOLT	(N)	PERNO MINIFIX	(N)		12
PASSA FIO 40mm	(O)	40mm CABLE GROMMET	(O)	PASACABLES 40mm	(O)		01
PINO SUPORTE	(P)	SHELF SUPPORT	(P)	SOPORTE DE ESTANTE	(P)		08
PREGO 8x8 C/C	(Q)	8x8 NAIL	(Q)	CLAVO 8x8	(Q)		32
SACHE DE COLA	(R)	GLUE SACHET	(R)	BOLSITA DE PEGAMENTO	(R)		01
SAPATA DESLIZANTE	(S)	GLIDE	(S)	PATÍN	(S)		06
TAMBOR MINIFIX 12x10mm	(T)	12x10mm MINIFIX CAM	(T)	CAJA MINIFIX 12x10mm	(T)		12

RELAÇÃO DE PEÇAS | PARTS LIST | LISTADO DE PARTES

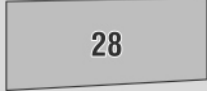
	Base Bottom Base Base	1Pc		Tampo Superior TV Panel Top Tapa del Panel de TV	1Pc
	Tampo Porta TV Stand Top Tapa de la Mesa de TV	1Pc		Lateral Esquerda Nicho Cube Unit Left Side Lateral Izquierdo del Cubo	1Pc
	Rodapé Frontal Front Toe Zócalo Trasero	1Pc		Lateral Direita Nicho Cube Unit Right Side Lateral Derecho del Cubo	1Pc
	Rodapé Traseiro Back Toe Zócalo Trasero	1Pc		Divisão Nicho Cube Unit Divider División del Cubo	1Pc
	Rodapé Lateral Side Toe Zócalo Lateral	2Pcs		Tampo Nicho Cube Unit Top Tapa del Cubo	1Pc
	Rodapé Interno Internal Toe Zócalo Interno	2Pcs		Base Nicho Cube Unit Bottom Base del Cubo	1Pc
	Batente Porta Door Stop Panel Panel Batiente de Puerta	2Pcs		Prateleira Nicho Cube Unit Shelf Estante del Cubo	2Pcs
	Suporte Tampo Meio Shelf Support Soporte de Estante	1Pc		Porta Door Puerta	4Pcs
	Lateral Inferior Esquerda TV Stand Left Side Lateral Izquierdo de la Mesa de TV	1Pc		Painel Inferior Lower Panel Panel Inferior	1Pc
	Lateral Inferior Direita TV Stand Right Side Lateral Derecho de la Mesa de TV	1Pc		Painel Central Middle Panel Panel Central	1Pc
	Divisão inferior Central TV Stand Divider División de la Mesa de TV	1Pc		Painel Superior Upper Panel Panel Superior	1Pc
	Lateral Superior Esquerda TV Panel Left Side Lateral Izquierdo del Panel TV	1Pc		Tampo Meio TV Stand Shelf Estante de la Mesa de TV	1Pc
	Lateral Superior Direita TV Panel Right Side Lateral Derecho del Panel TV	1Pc		Chapéu Superior Top Shelf Estante Superior	1Pc
	Reforço Superior Painel TV Panel Back Reinforcement Refuerzo Trasero del Panel de TV	1Pc		Costas Inferior TV Stand Back Trasera de la Mesa de TV	2Pcs

- PASSO 01** COMECE A MONTAGEM PELA PEÇA 2. PARAFUSE AS RIPAS NA PEÇA 7 CONFORME ZOOM COM PARAFUSO 3,5x25 (J). ENCAIXE AS PEÇAS 7 NA PEÇA 2 COM CAVILHA 6x30 (C). EM SEGUIDA, ENCAIXE AS PEÇAS 9, 10, 11 NA PEÇA 2 COM MINIFIXI (N+T).
- STEP 01** START THE ASSEMBLY BY PART 2. FASTEN THE WOODEN STRIPS TO PART 7 WITH 3,5x25 SCREWS (J), ACCORDING TO THE PICTURE. FASTEN PARTS 7 TO PART 2 WITH 6x30 DOWELS (C) THEN FASTEN PARTS 9, 10, AND 11 TO PART 2 WITH MINIFIXI (N+T).
- PASO 01** EMPIECE EL MONTAJE POR LA PARTE 2. FIJE LOS LISTONES DE MADERA A LA PARTE 7 CON TORNILLOS 3,5x25 (J), SEGÚN EL DISEÑO. FIJE LAS PARTES 7 A LA PARTE 2 CON CLAVIJAS 6x30 (C) DESPUÉS FIJE LAS PARTES 9, 10 Y 11 A LA PARTE 2 CON MINIFIXI (N+T).

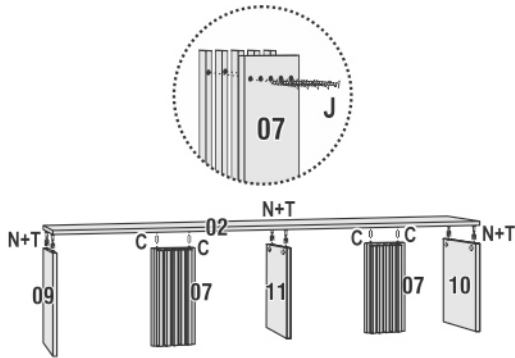

C = 4 J = 20 N = 6 T = 6

- PASSO 02** ENCAIXE A PEÇA 1 NAS PEÇAS 7 COM CAVILHA 6x30 (C). PARAFUSE A PEÇA 1 NAS PEÇAS 9, 10 E 11 COM PARAFUSO 5x40 (L).

STEP 02 FASTEN PART 1 TO PARTS 7 WITH 6x30 DOWELS (C). FASTEN PART 1 TO PARTS 9, 10, AND 11 WITH 5x40 SCREWS (L).

PASO 02 FIJE LA PARTE 1 A LAS PARTES 7 CON CLAVIJAS 6x30 (C). FIJE LA PARTE 1 A LAS PARTES 9, 10 Y 11 CON TORNILLOS 5x40 (L).

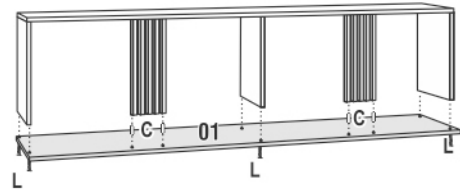

C = 4 L = 6

- PASSO 03** FAÇA A MONTAGEM DO RODAPÉ COM AS RESPECTIVAS FERRAGENS E DESENHO ABAIXO.
- STEP 03** ATTACH THE TOEKICK PARTS WITH THEIR RESPECTIVE HARDWARE, ACCORDING TO THE PICTURE.

PASO 03 MONTE LAS PARTES DEL ZÓCALO CON SUS RESPECTIVOS HERRAJES, SEGÚN EL DISEÑO.

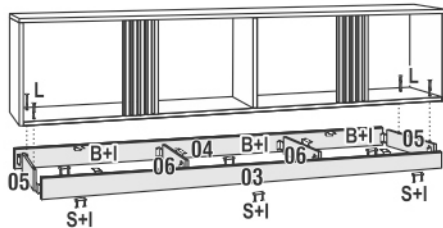

B = 14 I = 68 L = 4 S = 6

- PASSO 04** PARAFUSE A PEÇA 8 NA PEÇA 2 COM PARAFUSO 5x40 (L). ENCAIXE A PEÇA 26 NA PEÇA 8 COM MINIFIXI (N+T).

STEP 04 FASTEN PART 8 TO PART 2 WITH 5x40 SCREWS (L). FASTEN PART 26 TO PART 8 WITH MINIFIXI (N+T).

PASO 04 FIJE LA PARTE 8 A LA PARTE 2 CON TORNILLOS 5x40 (L). FIJE LA PARTE 26 A LA PARTE 8 CON MINIFIXI (N+T).

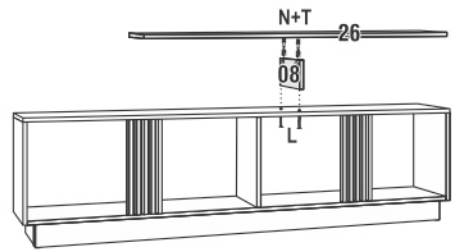

L = 2 N = 2 T = 2

- PASSO 05** PARAFUSE AS PEÇAS 12, 13 E 14 NA PEÇA 2 COM PARAFUSO 5x40 (L). PARAFUSE A PEÇA 23 NAS PEÇAS 2, 12, 13 E 14 COM CANTONEIRA 4 FUROS (B+H) E NA PEÇA 26 COM PARAFUSO 5x40 FLANGEADO (K) PARAFUSE A PEÇA 15 COM PARAFUSO 5x40 (L).

STEP 05 FASTEN PARTS 12, 13, AND 14 TO PART 2 WITH 5x40 SCREWS (L). FASTEN PART 23 TO PARTS 2, 12, 13, AND 14 WITH 4-HOLE ANGLE BRACKETS (B+H), AND FASTEN IT TO PART 26 WITH 5x40 FLANGE SCREWS (K) FASTEN PART 15 WITH 5x40 SCREWS (L).

PASO 05 FIJE LAS PARTES 12, 13 Y 14 A LA PARTE 2 CON TORNILLOS 5x40 (L). FIJE LA PARTE 23 A LAS PARTES 2, 12, 13 Y 14 CON REFUERZOS DE ÁNGULO 4 AGUJEROS (B+H), Y FIJÉLA A LA PARTE 26 CON TORNILLOS FLANGE 5x40 (K) FIJE LA PARTE 15 CON TORNILLOS 5x40 (L).

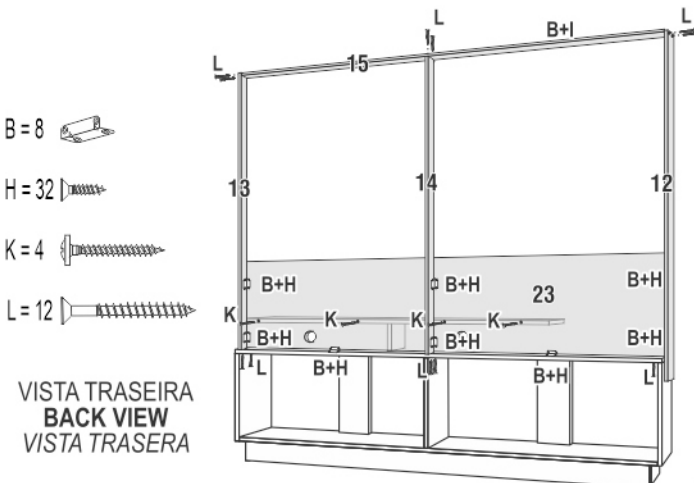

B = 8

H = 32

K = 4

L = 12

VISTA TRASEIRA
BACK VIEW
VISTA TRASERA

- PASSO 06** FAÇA A UNIÃO DOS PAINÉIS 24 E 25 COM CHAPA UNIÃO (E+H). PARAFUSE AS PEÇAS 24 E 25 NAS PEÇAS 12, 13, 14, 15 E 23 COM CANTONEIRA 4 FUROS (B+H).

STEP 06 ATTACH PANELS 24 AND 25 WITH 4-HOLE CONNECTION PLATES (E+H). FASTEN PARTS 24 AND 25 TO PARTS 12, 13, 14, 15 AND 23 WITH 4-HOLE ANGLE BRACKETS (B+H).

PASO 06 UNA LOS PANELES 24 Y 25 CON PLACAS DE UNIÓN 4 AGUJEROS (E+H). FIJE LAS PARTES 24 Y 25 A LAS PARTES 12, 13, 14, 15 Y 23 CON REFUERZOS DE ÁNGULOS 4 AGUJEROS (B+H).

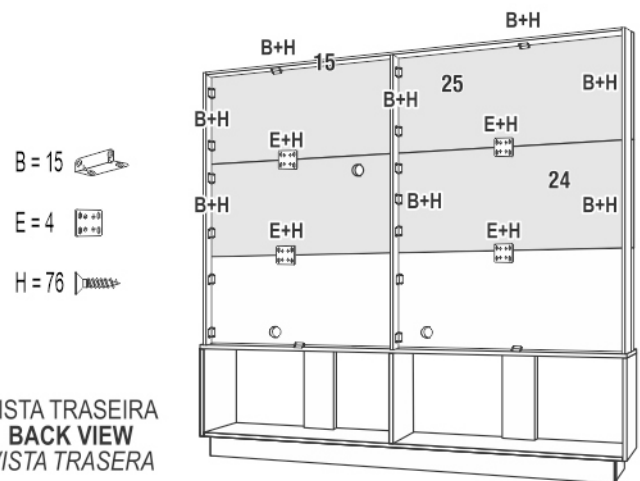

B = 15

E = 4

H = 76

VISTA TRASEIRA
BACK VIEW
VISTA TRASERA

PASSO 07 PARAFUSE A PEÇA 27 NA PEÇA 25 COM PARAFUSO 5x50 (M).
STEP 07 FASTEN PART 27 TO PART 25 WITH 5x50 SCREWS (M).
 PASO 07 AGUJEROS (B+I). FIJE LA PARTE 27 A LA PARTE 25 CON TORNILLOS 5x50 (M).

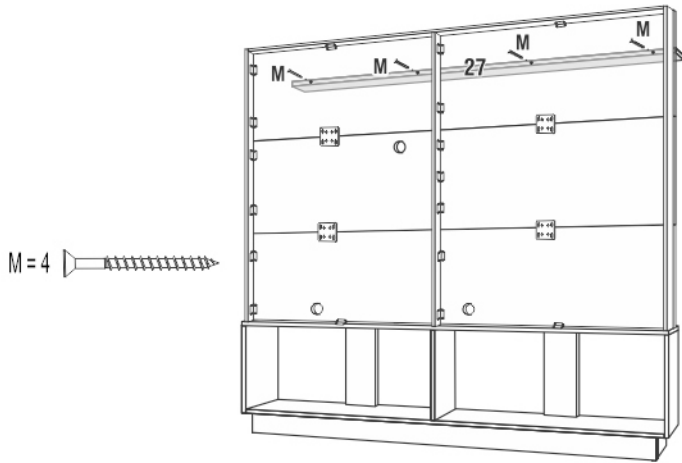

M = 4

VISTA TRASEIRA
BACK VIEW
 VISTA TRASERA

PASSO 08 ENCAIXE AS PEÇAS 16, 17 E 18 NA PEÇA 19. EM SEGUIDA, ENCAIXE AS PEÇAS 16, 17 E 18 NA PEÇA 20 COM AS RESPECTIVAS FERRAGENS, CONFORME DESENHO ABAIXO.

STEP 08 ATTACH PARTS 16, 17, AND 18 TO PART 19. THEN FASTEN PARTS 16, 17, AND 18 TO PART 20 WITH THEIR RESPECTIVE HARDWARE, ACCORDING TO THE PICTURE.

PASO 08 ENCAJE LAS PARTES 16, 17 Y 18 EN LA PARTE 19. DESPUÉS, FIJE LAS PARTES 16, 17 Y 18 A LA PARTE 20 CON SUS RESPECTIVOS HERRAJES, SEGUN EL DISEÑO.

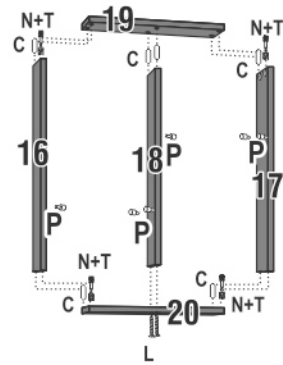

C = 6 L = 2 N = 4 T = 4 P = 8

PASSO 09 PARAFUSE O NICHU MONTADO NAS PEÇAS 23 E 24 COM PARAFUSO 5x40 (L).
STEP 09 FASTEN THE CUBE UNIT ASSEMBLED TO PARTS 23 AND 24 WITH 5x40 SCREWS (L).
 PASO 09 FIJE EL CUBO MONTADO A LAS PARTES 23 Y 24 CON TORNILLOS 5x40 (L).

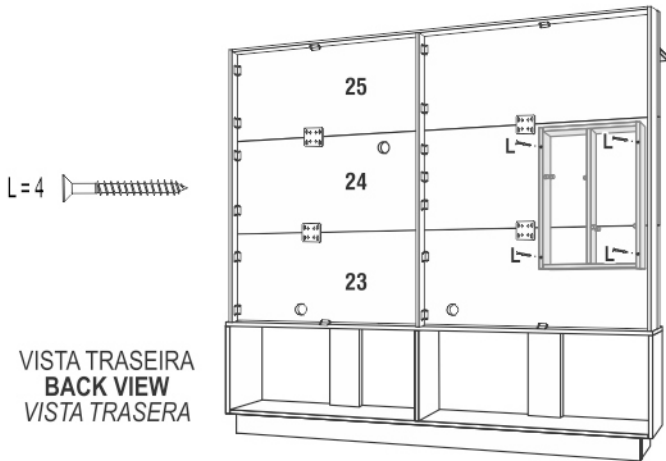

L = 4

VISTA TRASEIRA
BACK VIEW
 VISTA TRASERA

PASSO 10 ENCAIXE OS TUBOS COM CAVILHA 8x30 (D) E COLA (R), CONFORME ZOOM, E PARAFUSE-OS NAS PEÇAS 2 E 25 COM PARAFUSO 3,5x25 (J).

STEP 10 ATTACH THE TUBES WITH 8x30 DOWELS (D) AND GLUE (R), AND FASTEN THEM TO PARTS 2 AND 25 WITH 3,5x25 SCREWS (J).

PASO 10 ENCAJE LOS TUBOS CON CLAVIJAS 8x30 (D) Y PEGAMENTO (R), Y FÍJELOS A LAS PARTES 2 Y 25 CON TORNILLOS 3,5x25 (J).

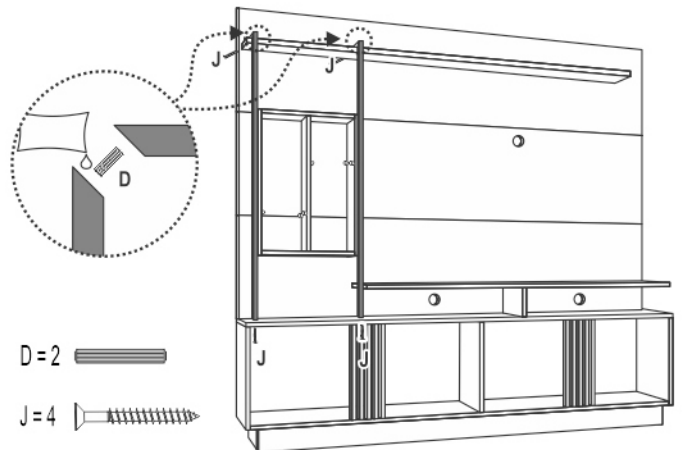

D = 2

J = 4

PASSO 11 PREGUE AS COSTAS COM PREGO 8x8 (Q).
STEP 11 FASTEN THE BACK WITH NAILS 8x8 (Q).
 PASO 11 FIJE LAS TRASERAS CON CLAVOS 8x8 (Q).

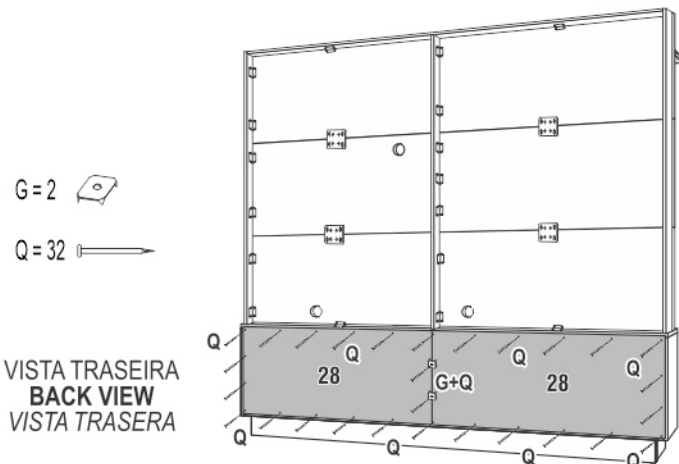

G = 2

Q = 32

VISTA TRASEIRA
BACK VIEW
 VISTA TRASERA

PASSO 12 FAÇA A MONTAGEM DAS PORTAS 22 COM AS RESPECTIVAS FERRAGENS E MONTE AS MESMAS, COLOCANDO AS PRATELEIRAS SOLTAS 21 E O PASSA FIO (O) CONFORME DESENHO ABAIXO.

STEP 12 ASSEMBLE AND FASTEN THE DOORS 22 WITH THEIR RESPECTIVE HARDWARE. PLACE THE CUBE SHELVES 21 AND THE INSERT THE CABLE GROMMET (O).

PASO 12 MONTE Y FIJE LAS PUERTAS 22 CON SUS RESPECTIVOS HERRAJES. PONGA LOS ESTANTES DEL CUBO 21 Y EL PASACABLES (O).

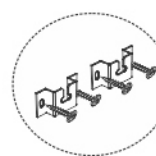

SIGA AS ORIENTAÇÕES QUE SE ENCONTRAM DENTRO DO KIT DO SUPORTE. FOLLOW THE INSTRUCTIONS THAT ARE INSIDE THE TV RACK KIT. SIGA LAS INSTRUCCIONES QUE SE ENCUENTRAN EN EL KIT DEL SOPORTE DE TV.

AO FIXAR O SUPORTE NA TV, PARAFUSOS PODEM SOBRRAR, DEPENDENDO DO TAMAHO DA TV. WHEN FASTENING THE TV RACK, SOME SCREWS MAY BE LEFT, DEPENDING ON THE TV SIZE. AL FIJAR EL SOPORTE DE TV, ALGUNOS TORNILLOS PUEDEN SOBRRAR, DEPENDENDO DEL TAMAHO DE LA TV.

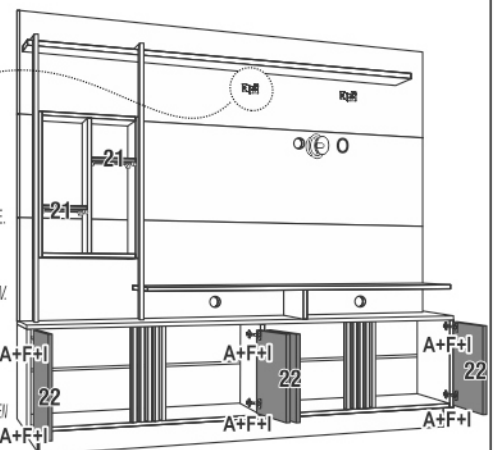

A = 8

F = 8

I = 32

O = 1